

LISTA DE PIEZAS

LADO LARGO

CABEZAS

PISOS

CUBIERTA

TIRANTES INTERNOS

ANILLOS DE SIERRE

PEINE LEDROSTEEL



**METALLURGICA
LEDRENSE**

SOC.COOP.



**LEDRO
STEEL BOX®**



LADO LARGO

alambre galvanizado - diám. 6 mm
malla 200 x 50 mm

Lado largo - altura 50 cm

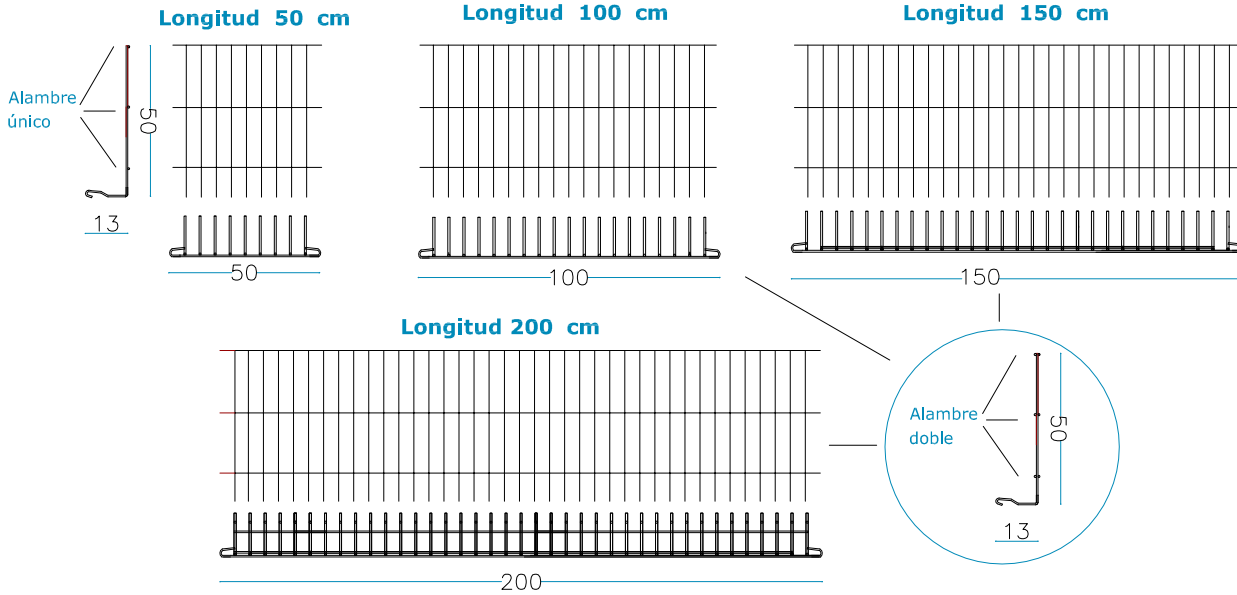

Lados largos H. 100 cm

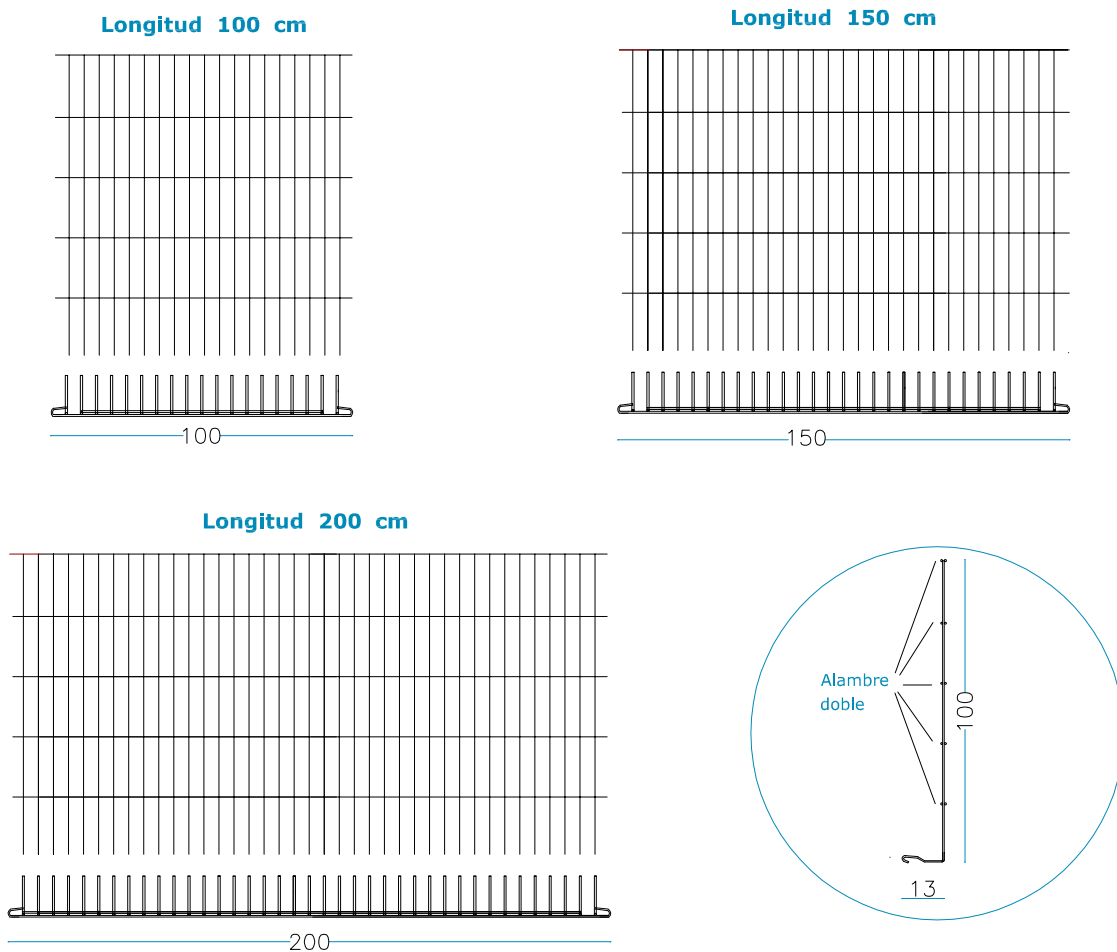

CABEZAS

alambre galvanizado - diám. 6 mm
malla 200 x 50 mm

Cabezas - altura 50 cm

Ancho 50 cm

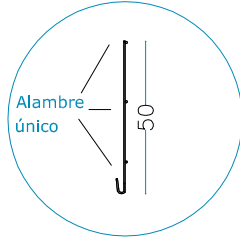
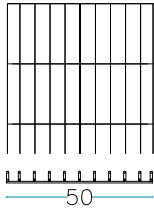

Ancho 75 cm

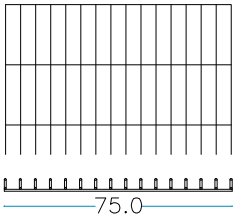

Ancho 100 cm

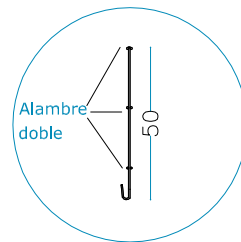
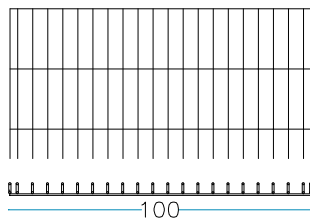

Cabezas - altura 100 cm

Ancho 50 cm

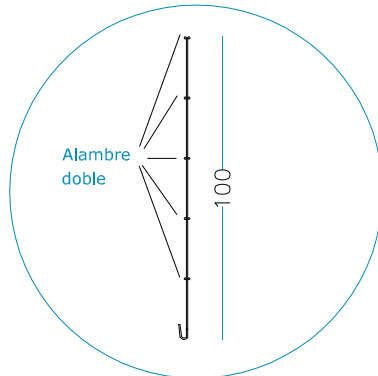
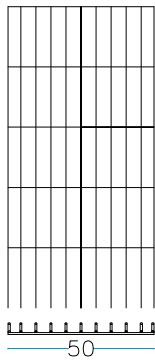

Ancho 75 cm

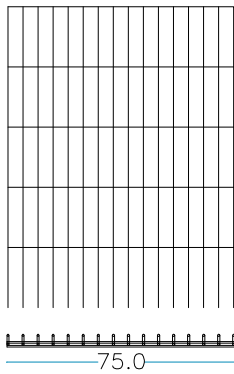

Ancho 100 cm

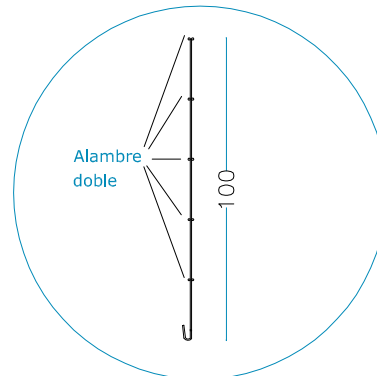
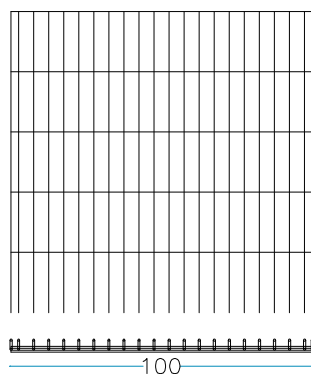

PISOS

alambre galvanizado - diám. 6 mm
malla 200 x 50 mm

Pisos ancho 50 cm

Longitud 50 cm

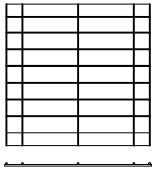

50

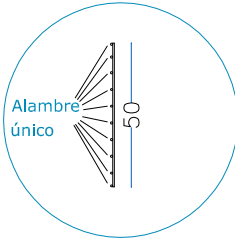

Longitud 100 cm

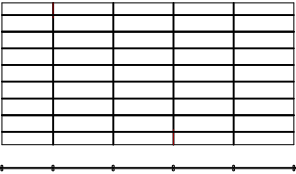

100

Longitud 150 cm

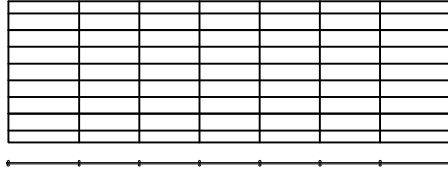

150

Longitud 200 cm

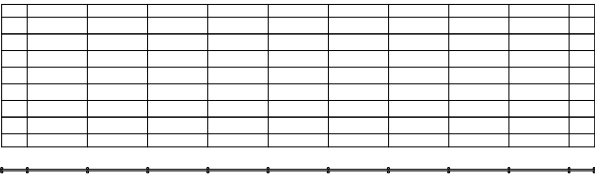

200

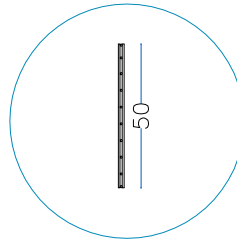

Pisos ancho 75 cm

Longitud 100 cm

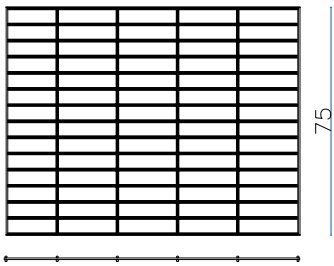

100

75

Longitud 150 cm

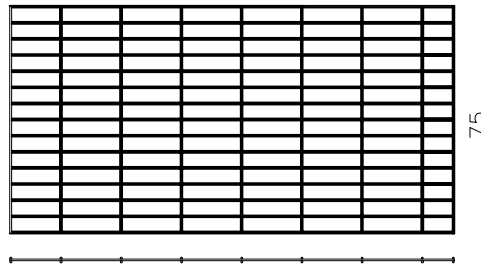

150

75

Longitud 200 cm

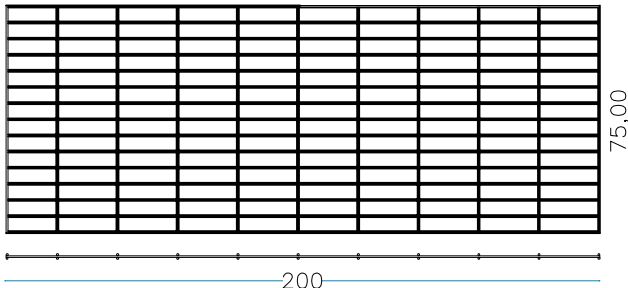

200

75,00

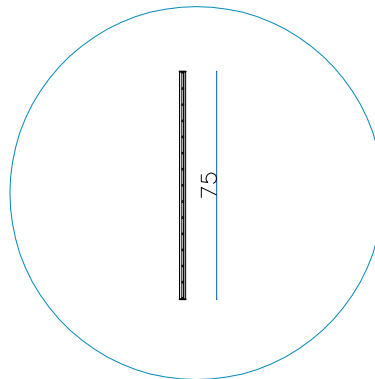

PISOS

alambre galvanizado - diám. 6 mm
malla 200 x 50 mm

Pisos ancho 100 cm

Longitud 100 cm

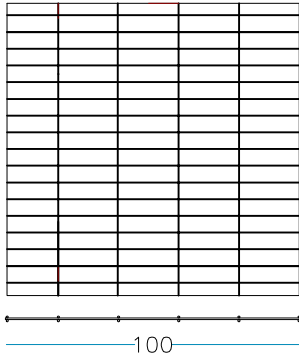

Longitud 150 cm

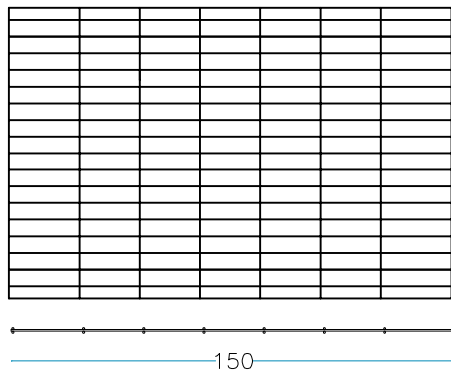

Longitud 200 cm

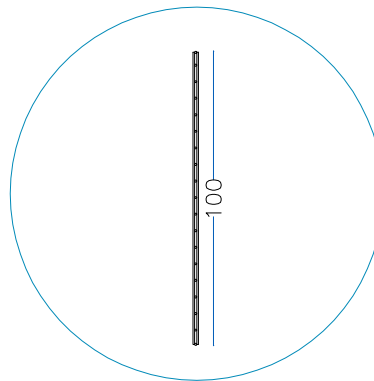
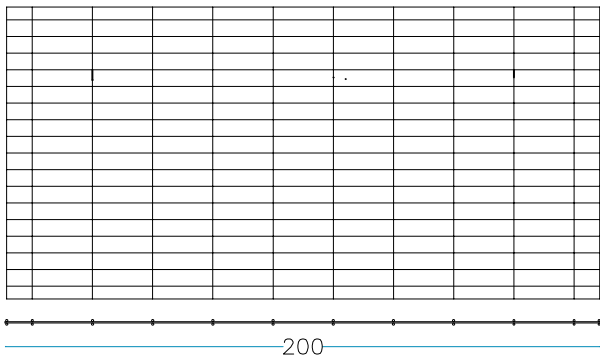

CUBIERTA

alambre galvanizado - diám. 6 mm
malla 200 x 50 mm

Cubierta ancho 50 cm

Longitud 50 cm

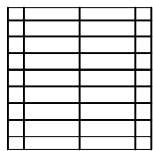

50

Longitud 100 cm

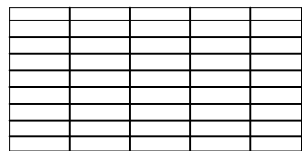

100

Longitud 150 cm

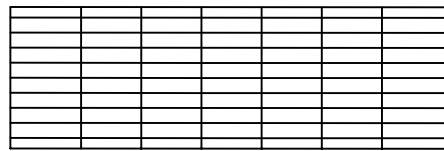

150

Longitud 200 cm

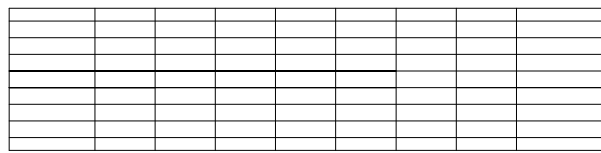

200

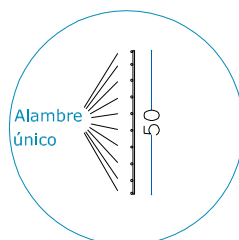

Alambre
único

50

Cubierta ancho 75 cm

Longitud 100 cm

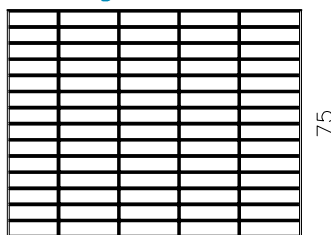

100

75

Longitud 150 cm

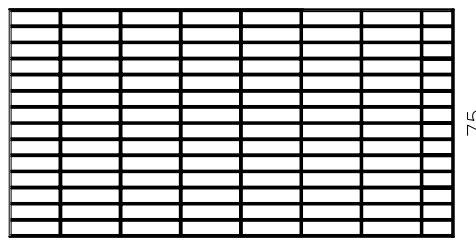

150

75

Longitud 200 cm

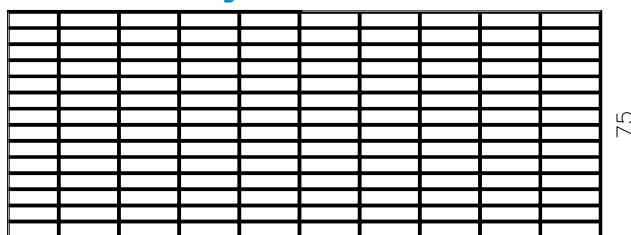

200

75

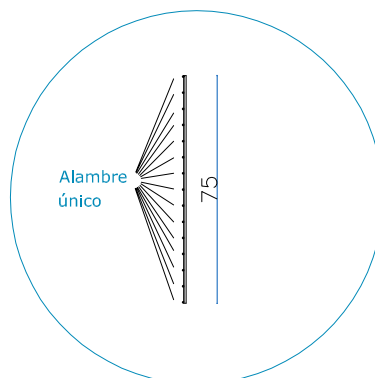

Alambre
único

75



CUBIERTA

alambre galvanizado - diám. 6 mm
malla 200 x 50 mm

Cubierta ancho 100 cm

Longitud 100 cm

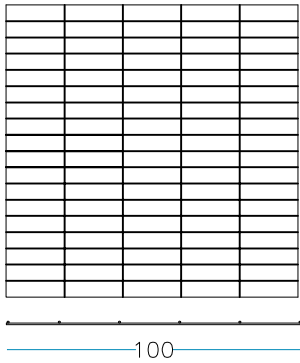

Longitud 150 cm

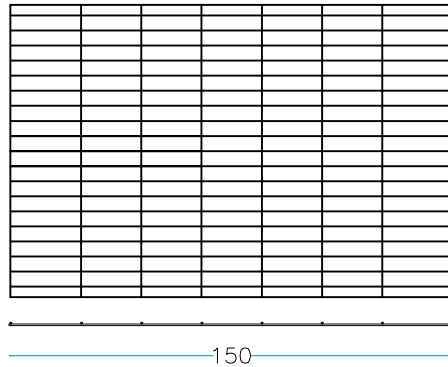

Longitud 200 cm

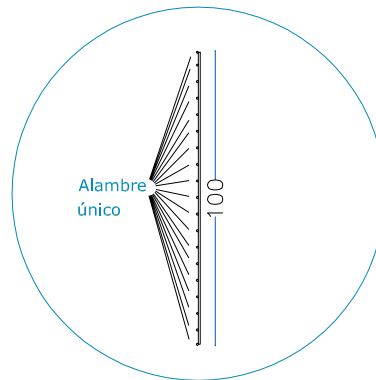
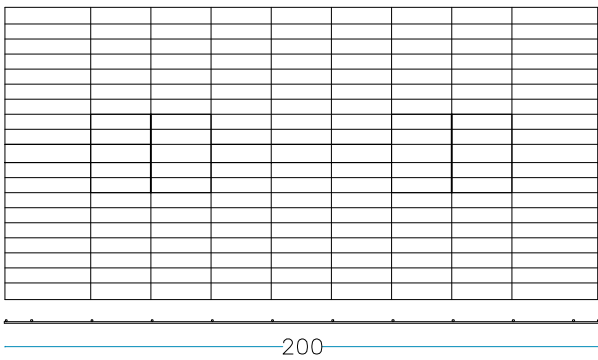

TIRANTES INTERNOS

alambre galvanizado - diám. 6 mm

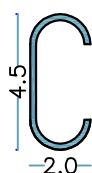
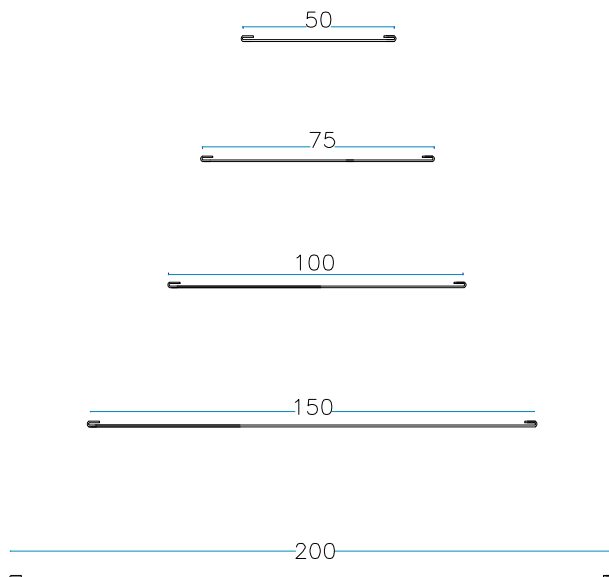

ANILLOS DE SIERRE

alambre galvanizado - diám. 3 mm

SISTEMA DE ELEVACIÓN PEINE LEDROSTEEL

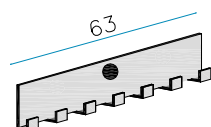

max 2000 Kg.

