

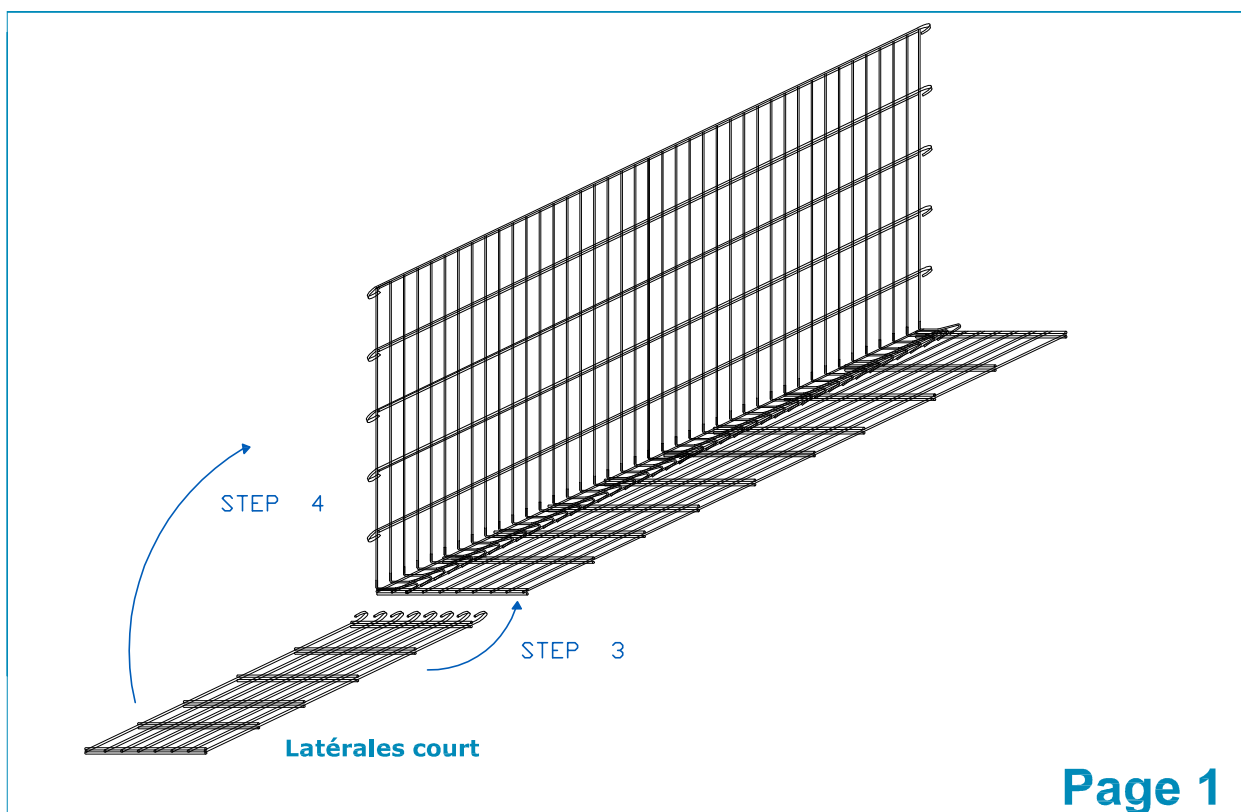

# GABION 200 x 50 x 100 cm.

fil zinc aluminium diamètre 6 mm - maille 200 x 50 mm

## INSTRUCTIONS DE MONTAGE

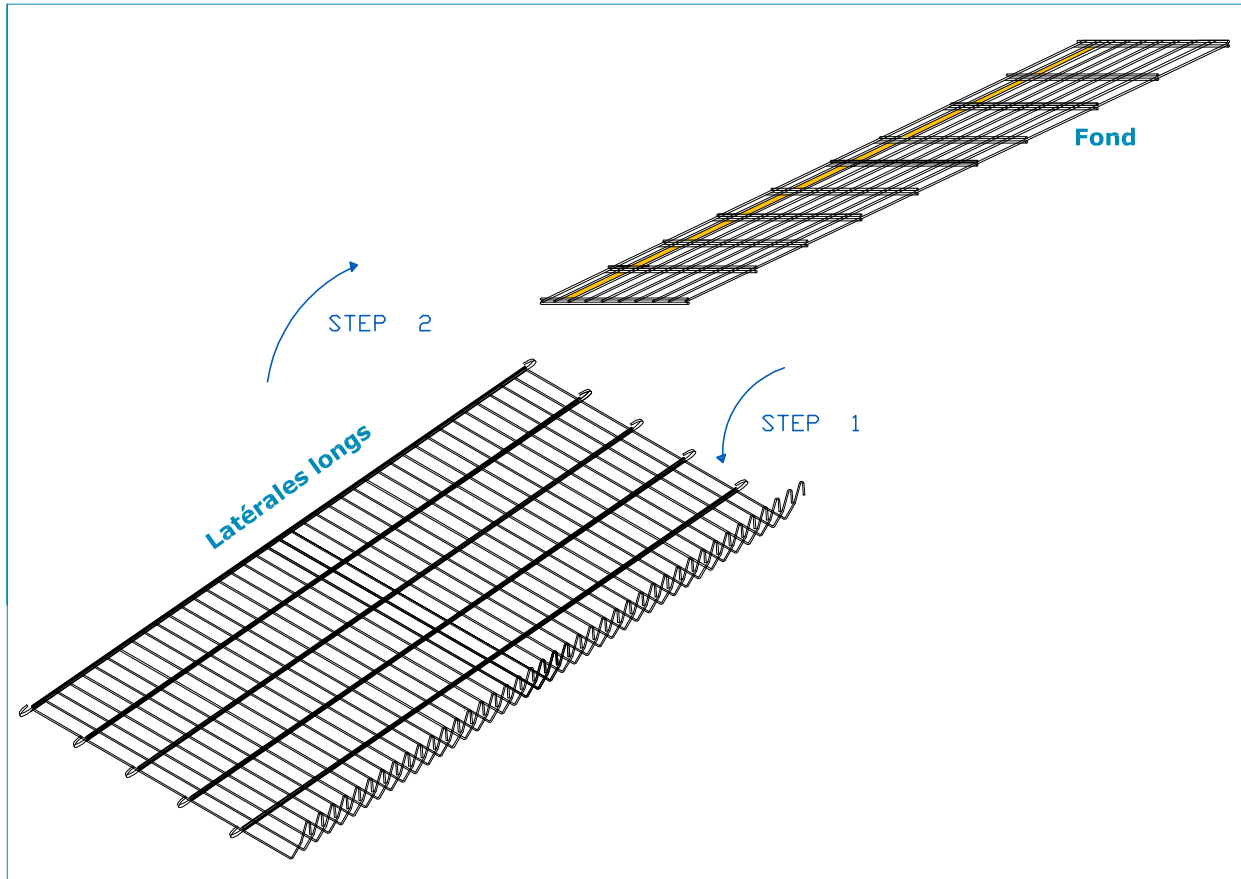

SYSTÈME  
ANTI-INONDATION



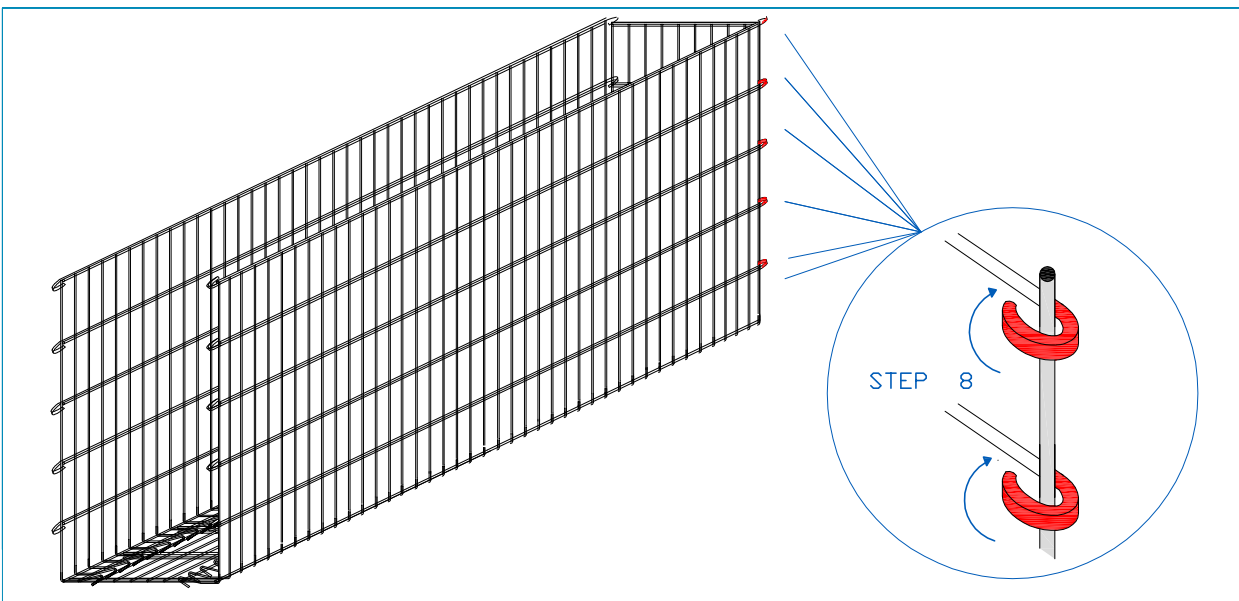
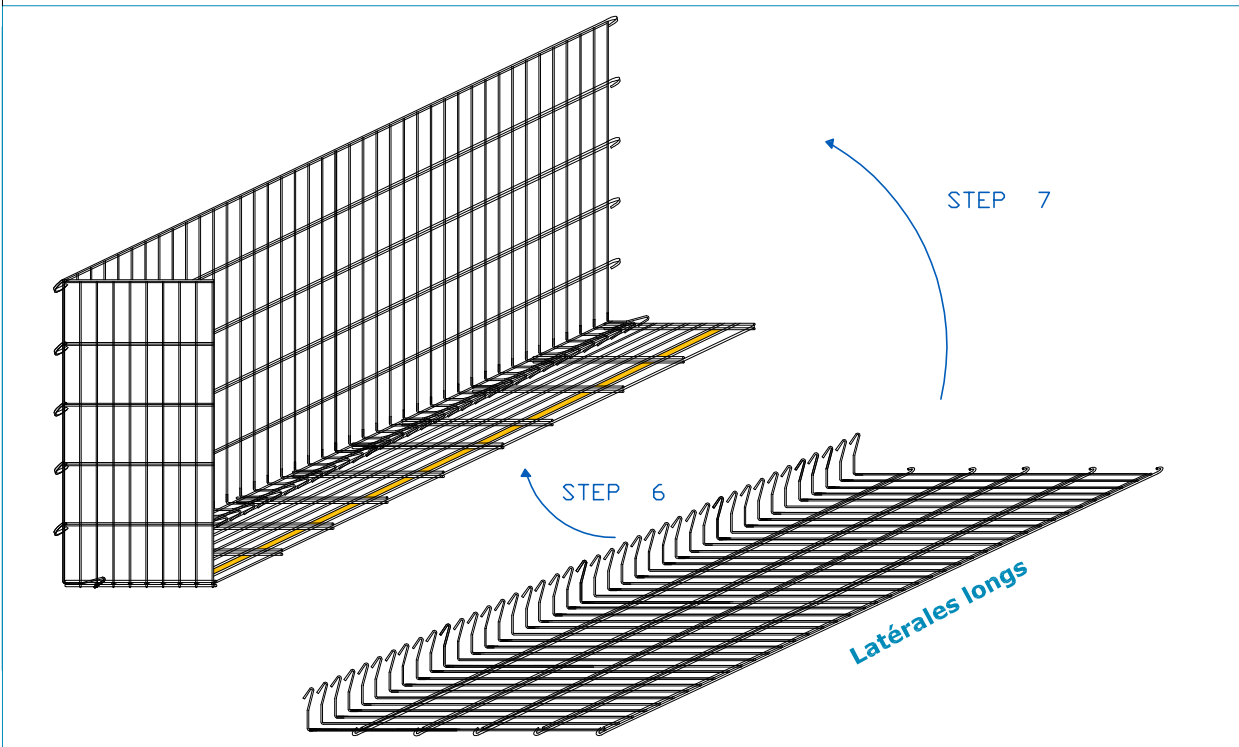
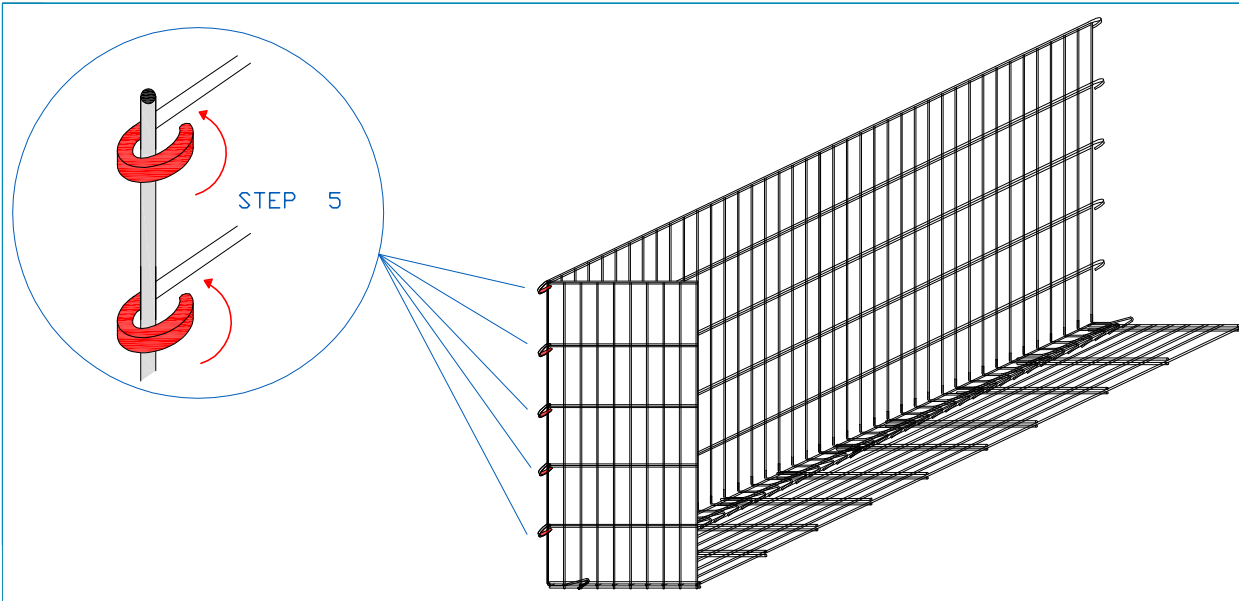

SYSTÈME  
ANTI-INONDATION



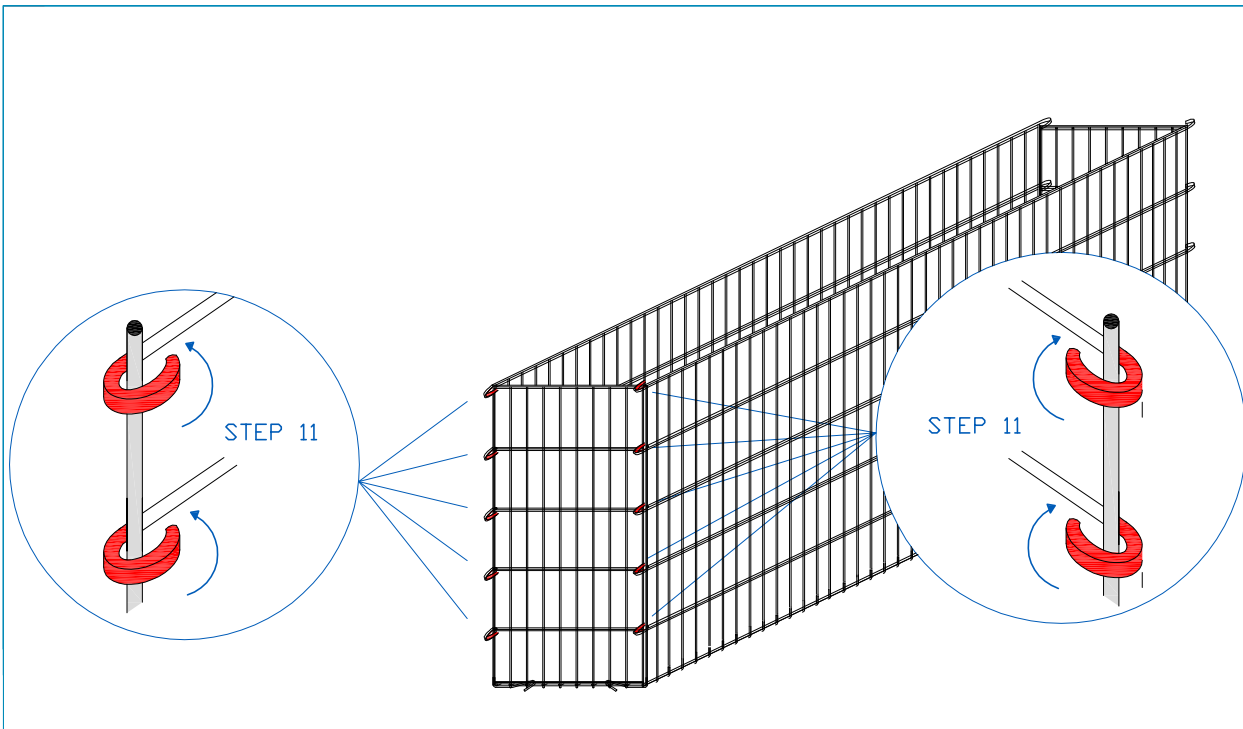
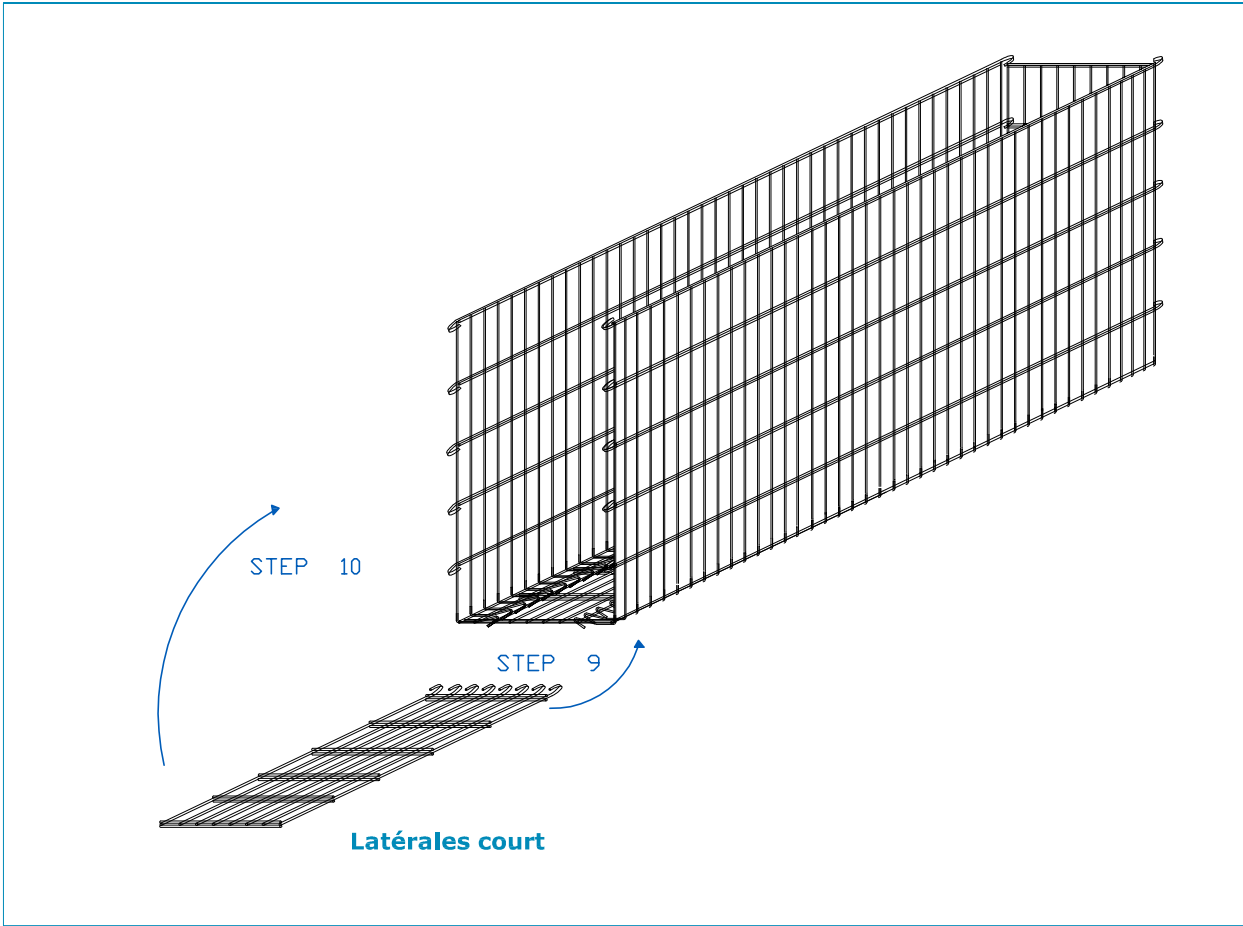

SYSTÈME ANTI-INONDATION





STEP 13 **Insérer le TISSU  
PRÉ-DIMENSIONNÉ  
SPÉCIFIQUE**

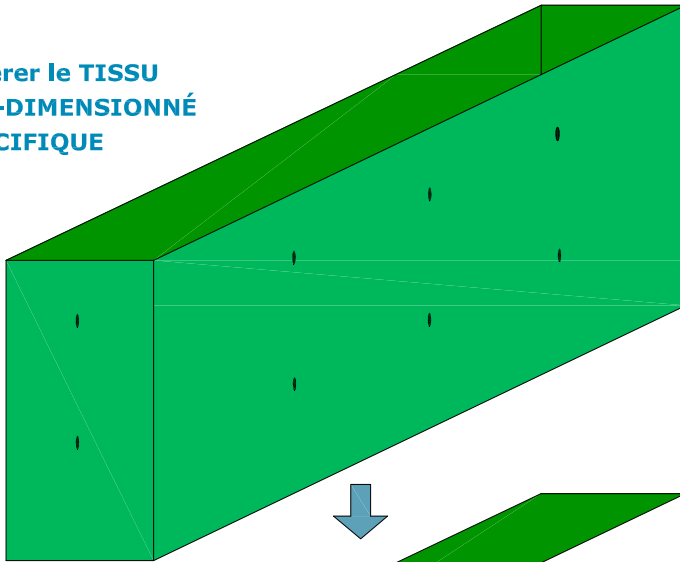

STEP 12  
**Insérer le REVÊTEMENT  
DE SOL  
(\* ) si nécessaire**

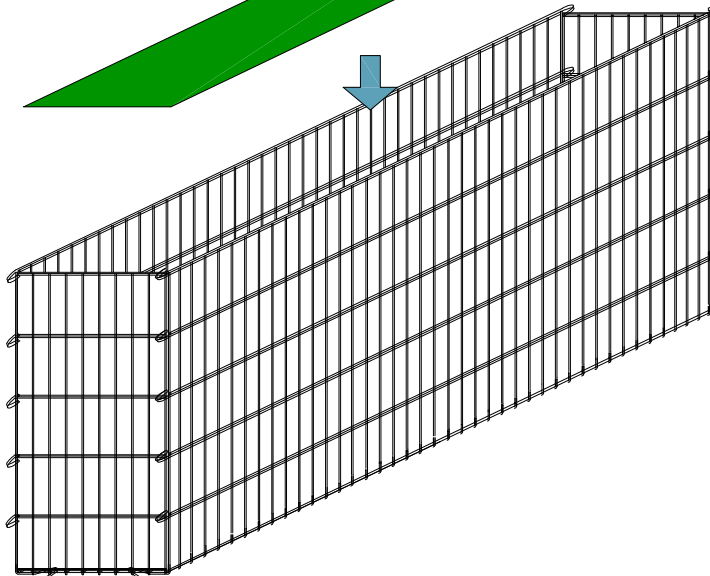

STEP 14  
**verrouillage du tissu**



**nr. 8 Anneaux  
de fermeture**

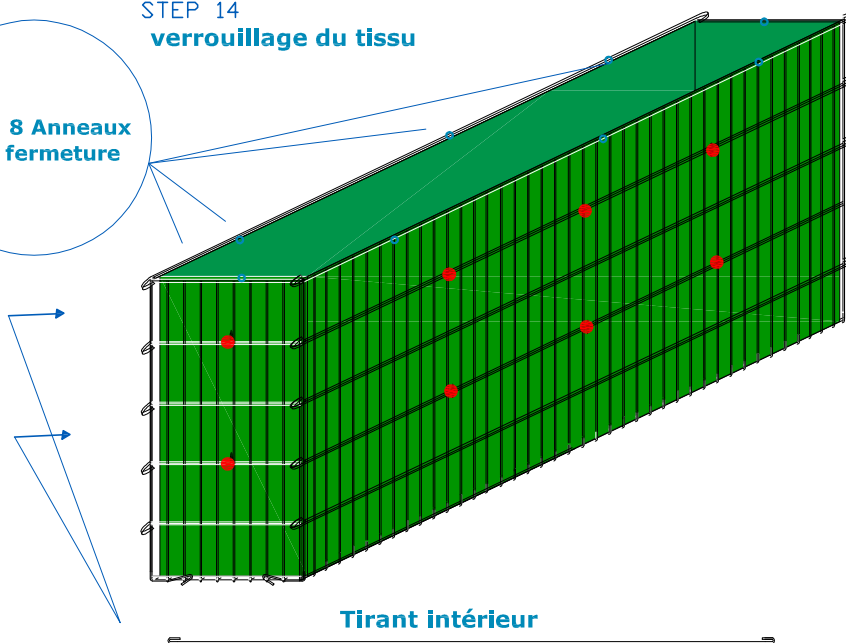

**Tirant intérieur**

STEP 15

**Tirant intérieur**

**SYSTÈME  
ANTI-INONDATION**





STEP 16 Couvercle

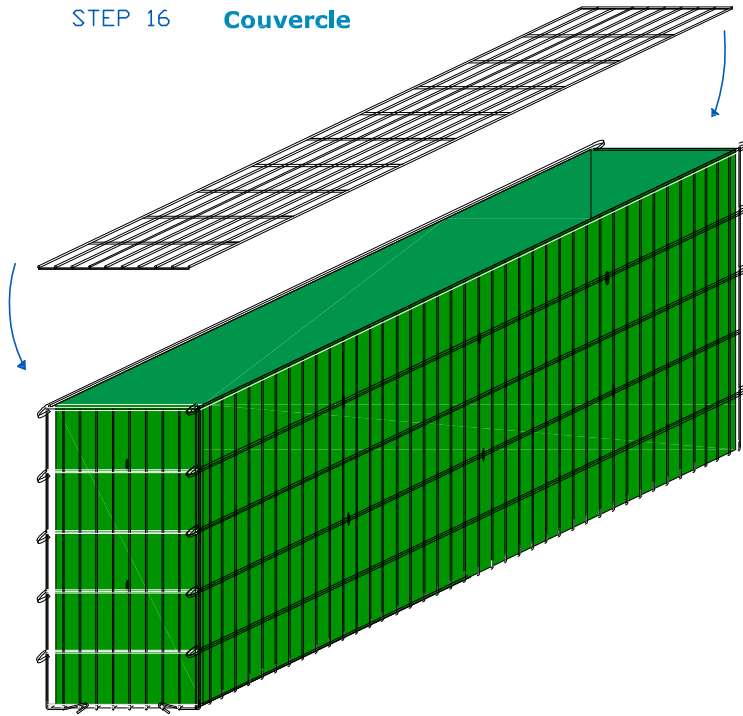

STEP 17

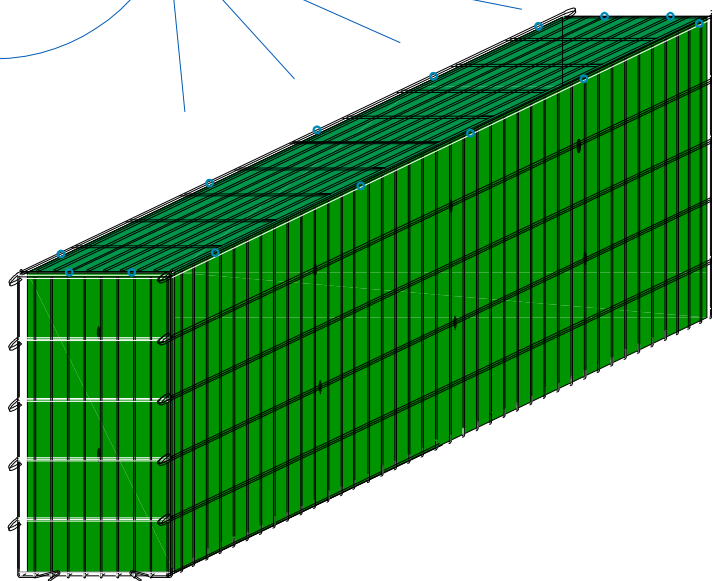

SYSTÈME ANTI-INONDATION





STEP 18

REPLISSAGE AVEC DU SABLE OU DU GRAIN  
FIN

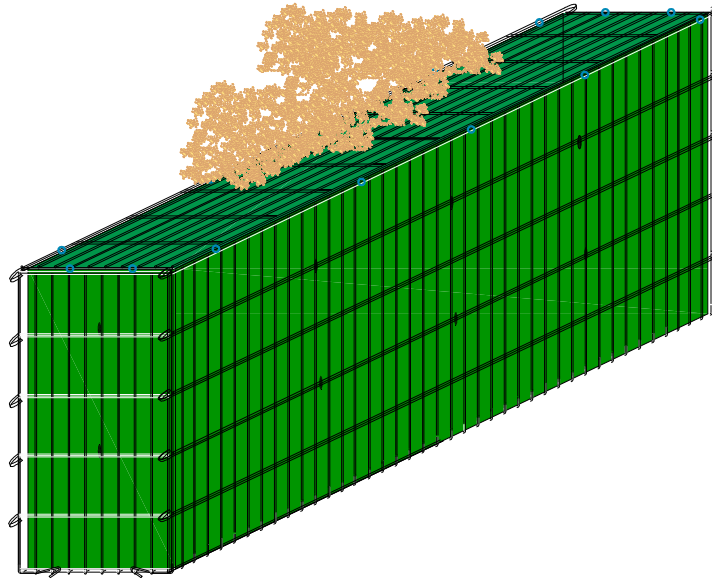

MANIPULATION AVEC PEIGNES DE LEVAGE

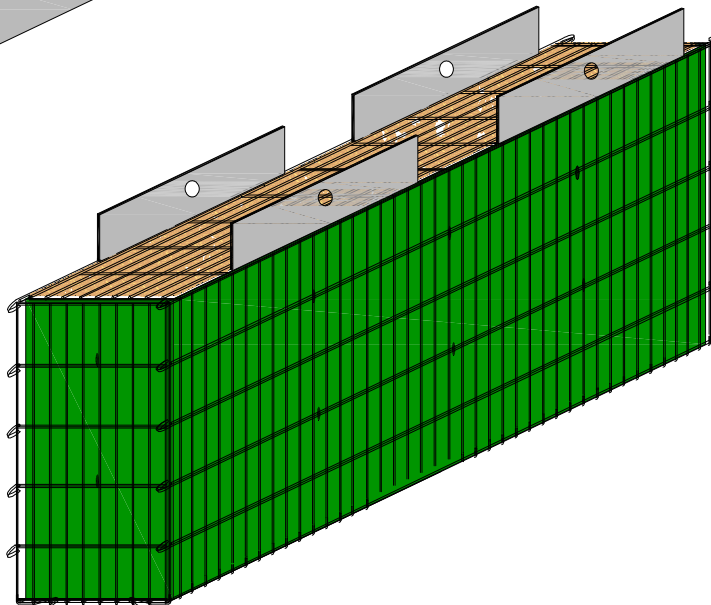
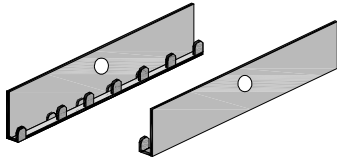

SYSTEME  
ANTI-FONDATEUR

